

DPC - DATAPATHS

Faster, Smaller, Lower Power

Use DPC to Make your Datapaths Faster,

Smaller,
Lower Power,
Easy to Route

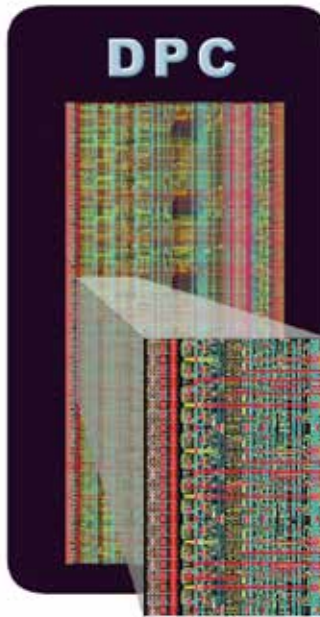
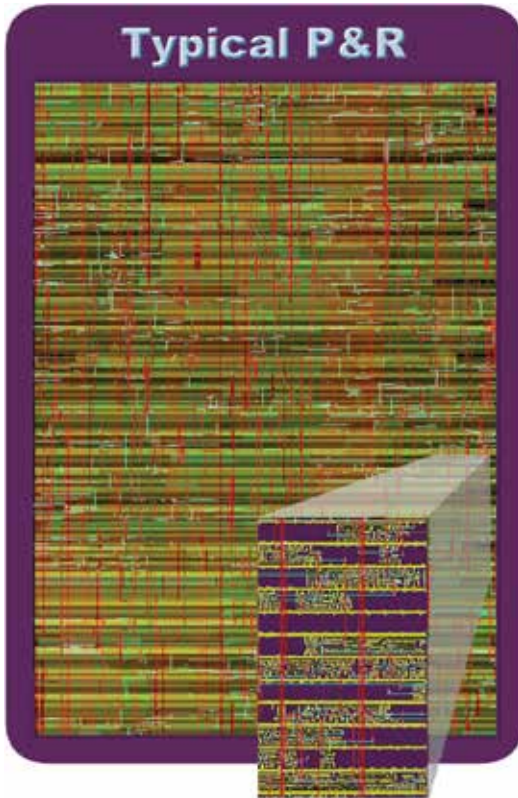

- Place, route and time 100K gates per minute.
- Regular bit-slice placement reduces congestion and wire length, reducing size and power.
- Gate Auto-sizer automatically improves timing and power.
- Uses all existing standard cell libraries.

Using DPC, engineers have produced real designs that were 3X faster, 40% smaller, and 40% lower power than their existing place & route design.

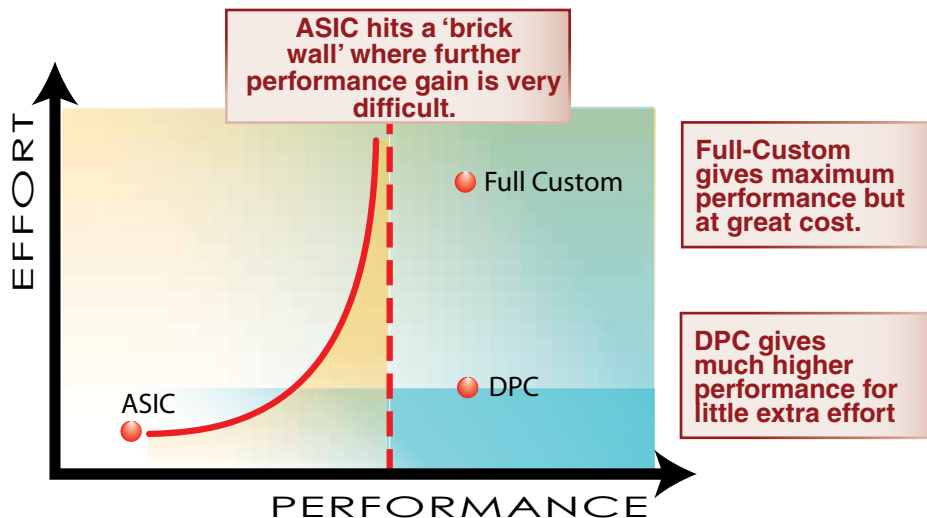

MMI tools greatly increase performance with very little increase in effort.

DPC

HIGH-PERFORMANCE DATAPATHS

Custom Performance with ASIC

HOW DPC SOLVES THE POWER/PERFORMANCE PROBLEM:

1. Import design data using schematics or Verilog.
2. Creates custom-like bit-slice placement which reduces congestion and improves routing.
3. Performs post-placement timing analysis.
4. Computes critical paths and provides timing information at each node.
5. Auto-sizes gates based on your constraints (optimizing for timing *and* power, or power alone).
6. Modify your design and see the new results very quickly. Iterations are done in minutes – DPC computes 100,000 gates per minute.
7. Checks for “hot spots” with congestion analysis.
8. Outputs a DEF placement file for your existing P&R flow.
9. Verifies timing post-route, and shows results graphically.

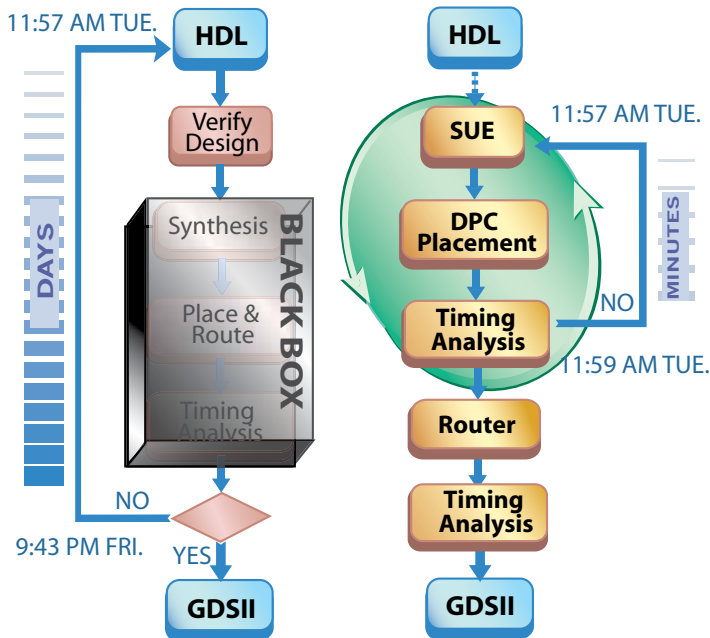

Standard ASIC flow is a “black box” providing little information. Iterations take days/weeks.

DPC flow provides timing feedback early in the design process. Iterations take seconds/minutes.

Control Your Placement

DPC gives the designer complete control of the datapath. You control relative placement of gates, and you can designate exact placement for specific gates.

Control Your Gate Sizing

DPC automatically sizes the gates in your datapath, using a production-proven algorithm to select optimal sizes for speed, power or both. Using the “power down” option, Auto-Sizer will only down-size gates in order to minimize power required. At your option, you can also manually resize gates.

SUE

SOC DESIGN MANAGER

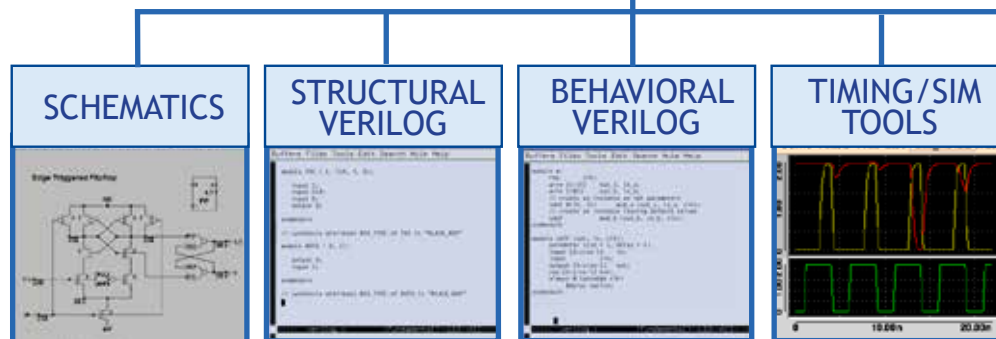

- The Framework for All Design Capture, Simulation, Timing and Data Management
- Manage Circuits, Verilog, Documentation and Version Control
- F S

Effort Greater Designer Control

Verilog or Schematics to enter design information.

CRITICAL PATH ANALYSIS
DPC computes placement, route, and timing information.

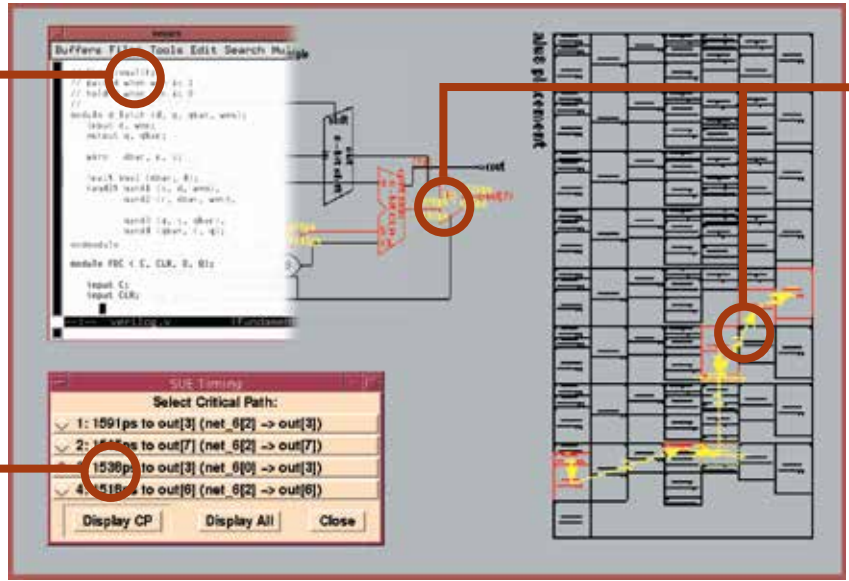

Critical paths are displayed on the schematic and placement views.

Timing Information and Critical-Path Analysis

DPC provides immediate timing feedback for placement and gate sizing. Multiple what-if experiments can be performed in seconds. Using a graphical display that back annotates timing to the schematic and placement file, you can easily identify timing problems and

rapidly iterate through solutions. DPC is so fast it can place, route, and time a 100,000 gate datapath in one minute.

Design Inputs

DPC reads your Verilog and produces a schematic. For designers who don't use schematics, there is a "Verilog-

Only" option. Once you are meeting your timing and power goals, you can use the built-in congestion analyzer to check for hot spots. Due to the regular bit-slice placement and congestion check, DPC blocks usually route correctly on the first pass.

A DEF placement file and the Verilog netlist is sent to your router.

DPC Incorporates SUE SoC Design Manager

Everything Needed to Manage Today's SoC Design Flow



Manage Your Design with SUE

SUE combines schematic capture and verification with control of Verilog blocks, timing models, standard cell libraries and documentation. SUE is useful from an architectural level to plan your design, and manage the design process.

- » Provides an architectural overview of your design.
- » Fully hierarchical, SUE can drill down to gate-level or transistor-level detail of any block.
- » Structural Verilog is imported and automatically arranged as a schematic.
- » Enter your designs quickly with the simple graphical user interface.

Fast and Effective Schematic Capture Tool

- Supports Industry Standard File Formats

- Drives Most Verilog and SPICE Simulators

ertful. Easy to Use

DPC Features

- Up to 300% Faster Datapath Performance, 40% Lower Power, 40% Less Area.
- Custom performance with ASIC effort.
- Quickly builds custom-like datapaths using all existing standard cell libraries.
- DPC includes its own timing analyzer, or you can use PrimeTime®.
- Fast – processes 100,000 gates per minute.
- Writes DEF placement information and a Verilog netlist for integration with routers.
- Available on LINUX.

SUE Features:

- » Draw, view, and edit schematics, icons, graphics, and text.
- » Automatically:
 - » Attach Verilog models and documentation to schematics.
 - » Generate Verilog from schematic symbols and vice versa.
 - » Generate layout when used with MAX-LS Layout System.
- » Highlight nets and cross-probe between layout and schematic.
- » Maintain multiple views (behavioral, RTL, structural) of schematics.
- » Interactive cross-probing during simulation on schematic or waveform tool.

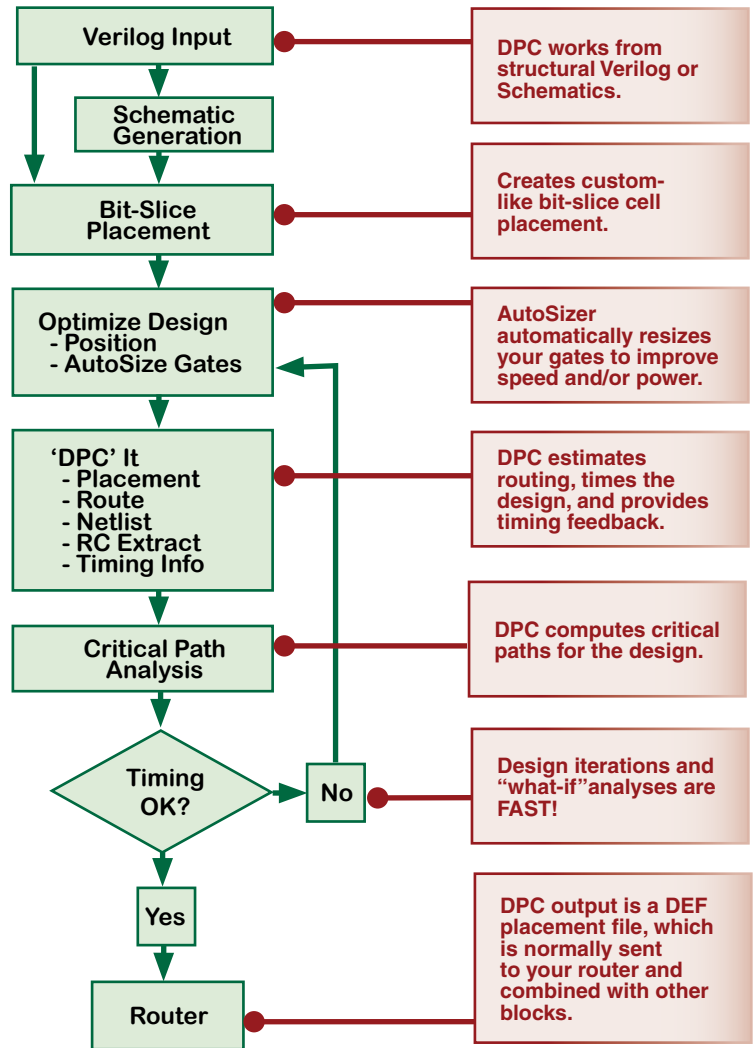

- » Includes waveform viewer.
- » Reads/writes OVI compliant Verilog files.
- » No Vendor Lock-in from proprietary file formats or encryption. ASCII database for transportability and ease of use with other programs and revision control.
- » Standard netlist and simulator interfaces.
- » Complete Tcl/Tk programming interface and API.